



Service Facts

Split System Cooling 4TTR6036A1000A

IMPORTANT — This document contains a wiring diagram, a parts list, and service information. This is customer property and is to remain with this unit. Please return to service information pack upon completion of work.

⚠ WARNING: HAZARDOUS VOLTAGE - DISCONNECT POWER and DISCHARGE CAPACITORS BEFORE SERVICING

⚠ CAUTION
UNIT CONTAINS R-410A REFRIGERANT!
 R-410A OPERATING PRESSURE EXCEEDS THE LIMIT OF R-22. PROPER SERVICE EQUIPMENT IS REQUIRED. FAILURE TO USE PROPER SERVICE TOOLS MAY RESULT IN EQUIPMENT DAMAGE OR PERSONAL INJURY.
SERVICE
 USE ONLY R-410A REFRIGERANT AND APPROVED POE COMPRESSOR OIL.

PRODUCT SPECIFICATIONS

OUTDOOR UNIT ①②	4TTR6036A1000A
POWER CONNS. — V/PH/HZ ③	208/230/1/60
MIN. BRCH. CIR. AMPACITY	24
BR. CIR. PROT. RTG. — MAX. (AMPS)	35
COMPRESSOR	CLIMATUFF® - SCROLL
NO. USED - NO. STAGES	1 - 2
VOLTS/PH/HZ	208/230/1/60
R.L. AMPS ⑦ - L.R. AMPS	17.0 - 82
FACTORY INSTALLED	
START COMPONENTS ⑧	NO
INSULATION/SOUND BLANKET	NO
COMPRESSOR HEAT	NO
OUTDOOR FAN	PROPELLER
DIA. (IN.) - NO. USED	27.6 - 1
TYPE DRIVE - NO. SPEEDS	DIRECT - 1
CFM @ 0.0 IN. W.G. ④	3700
NO. MOTORS - HP	1 - 1/8
MOTOR SPEED R.P.M.	835
VOLTS/PH/HZ	208/230/1/60
F.L. AMPS	0.74
OUTDOOR COIL — TYPE	SPINE FIN™
ROWS - F.P.I.	1 - 24
FACE AREA (SQ. FT.)	30.79
TUBE SIZE (IN.)	3/8
REFRIGERANT	R-410A
LBS. — R-410A (O.D. UNIT) ⑤	9 LBS.- 13 OZ.
FACTORY SUPPLIED	YES
LINE SIZE - IN. O.D. GAS ⑥	3/4
LINE SIZE - IN. O.D. LIQ. ⑥	3/8
CHARGING SPECIFICATION	
SUBCOOLING	9°F
DIMENSIONS	H X W X D
CRATED (IN.)	51.0 X 35.1 X 38.7
WEIGHT	
SHIPPING (LBS.)	283
NET (LBS.)	245

TUBING INFORMATION

Tubing Sizes		Tubing Length	Additional Refrigerant
Suction	Liquid		
3/4"	3/8"	20'	3 oz.
3/4"	3/8"	30'	9 oz.
3/4"	3/8"	40'	15 oz.
3/4"	3/8"	50'	21 oz.
3/4"	3/8"	60'	27 oz.

Tubing lengths in excess of sixty (60) feet see application software.

- ① Certified in accordance with the Air-Source Unitary Air-conditioner Equipment certification program, which is based on AHRI standard 210/240. In order to achieve AHRI standard rating, the indoor fan time delay on the comfort control must be enabled.
- ② Rated in accordance with AHRI standard 270.
- ③ Calculated in accordance with Natl. Elec. Codes. Use only HACR circuit breakers or fuses.
- ④ Standard Air — Dry Coil — Outdoor
- ⑤ This value approximate. For more precise value see unit nameplate.
- ⑥ Max. linear length 60 ft.; Max. lift - Suction 25 ft.; Max lift - Liquid 25 ft. For greater length consult refrigerant piping software Pub. No. 32-3312-0* (* denotes latest revision).
- ⑦ This value shown for compressor RLA on the unit nameplate and on this specification sheet is used to compute minimum branch circuit ampacity and max. fuse size. The value shown is the branch circuit selection current.
- ⑧ No means no start components. Yes means quick start kit components. PTC means positive temperature coefficient starter.

⚠ CAUTION
HOT SURFACE!
DO NOT TOUCH TOP OF COMPRESSOR.
 May cause minor to severe burning.

⚠ CAUTION
CONTAINS REFRIGERANT!
SYSTEM CONTAINS OIL AND REFRIGERANT UNDER HIGH PRESSURE. RECOVER REFRIGERANT TO RELIEVE PRESSURE BEFORE OPENING SYSTEM.
 Failure to follow proper procedures can result in personal illness or injury or severe equipment damage.

⚠ WARNING

THIS INFORMATION IS INTENDED FOR USE BY INDIVIDUALS POSSESSING ADEQUATE BACKGROUNDS OF ELECTRICAL AND MECHANICAL EXPERIENCE. ANY ATTEMPT TO REPAIR A CENTRAL AIR CONDITIONING PRODUCT MAY RESULT IN PERSONAL INJURY AND OR PROPERTY DAMAGE. THE MANUFACTURER OR SELLER CANNOT BE RESPONSIBLE FOR THE INTERPRETATION OF THIS INFORMATION, NOR CAN IT ASSUME ANY LIABILITY IN CONNECTION WITH ITS USE.

⚠ CAUTION

RECONNECT ALL GROUNDING DEVICES. ALL PARTS OF THIS PRODUCT CAPABLE OF CONDUCTING ELECTRICAL CURRENT ARE GROUNDED. IF GROUNDING WIRES, SCREWS, STRAPS, CLIPS, NUTS OR WASHERS USED TO COMPLETE A PATH TO GROUND ARE REMOVED FOR SERVICE, THEY MUST BE RETURNED TO THEIR ORIGINAL POSITION AND PROPERLY FASTENED.

NOTICE: The manufacturer has a policy of continuous product and product data improvement and reserves the right to change design and specifications without notice.

SCHEMATIC DIAGRAM

TO POWER SUPPLY PER UNIT NAMEPLATE AND LOCAL CODES

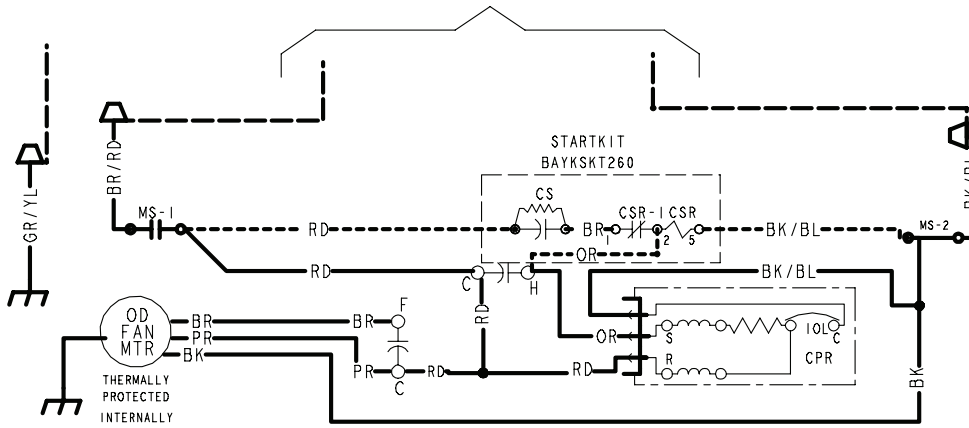

- ACR A/C RECTIFIER
- CF FAN CAPACITOR
- CN WIRECONNECTOR
- CPR COMPRESSOR
- CR RUN CAPACITOR
- CS STARTING CAPACITOR
- CSR CAPACITOR SWITCHING RELAY
- F INDOOR FAN RELAY
- HPCO HIGH PRESSURE CUTOUT SWITCH
- IOL INTERNAL OVERLOAD PROTECTOR
- LPCO LOW PRESSURE CUTOUT SWITCH
- SM SYSTEM ON-OFF SWITCH
- MS COMPRESSOR MOTOR CONTACTOR
- ODA OUTDOOR ANTICIPATOR
- OFT OUTDOOR FAN THERMOSTAT
- ODS OUTDOOR TEMPERATURE SENSOR
- ODT OUTDOOR THERMOSTAT
- SC SWITCH OVER VALVE SOLENOID
- TDL DISCHARGE LINE THERMOSTAT
- TDR TIME DELAY RELAY(5 SEC DELAY ON)
- TNS TRANSFORMER

← COLOR OF WIRE
BK/BL ← COLOR OF MARKER

- BK BLACK RD RED OR ORANGE
- BL BLUE WH WHITE GR GREEN
- BR BROWN YL YELLOW PR PURPLE
- PK PINK

⚠ WARNING

HAZARDOUS VOLTAGE!
DISCONNECT ALL ELECTRICAL POWER INCLUDING REMOTE DISCONNECTS BEFORE SERVICING.
Failure to disconnect power before servicing can cause severe personal injury or death.

⚠ CAUTION

USE COPPER CONDUCTORS ONLY!
UNIT TERMINALS ARE NOT DESIGNED TO ACCEPT OTHER TYPES OF CONDUCTORS.
Failure to do so may cause damage to the equipment.

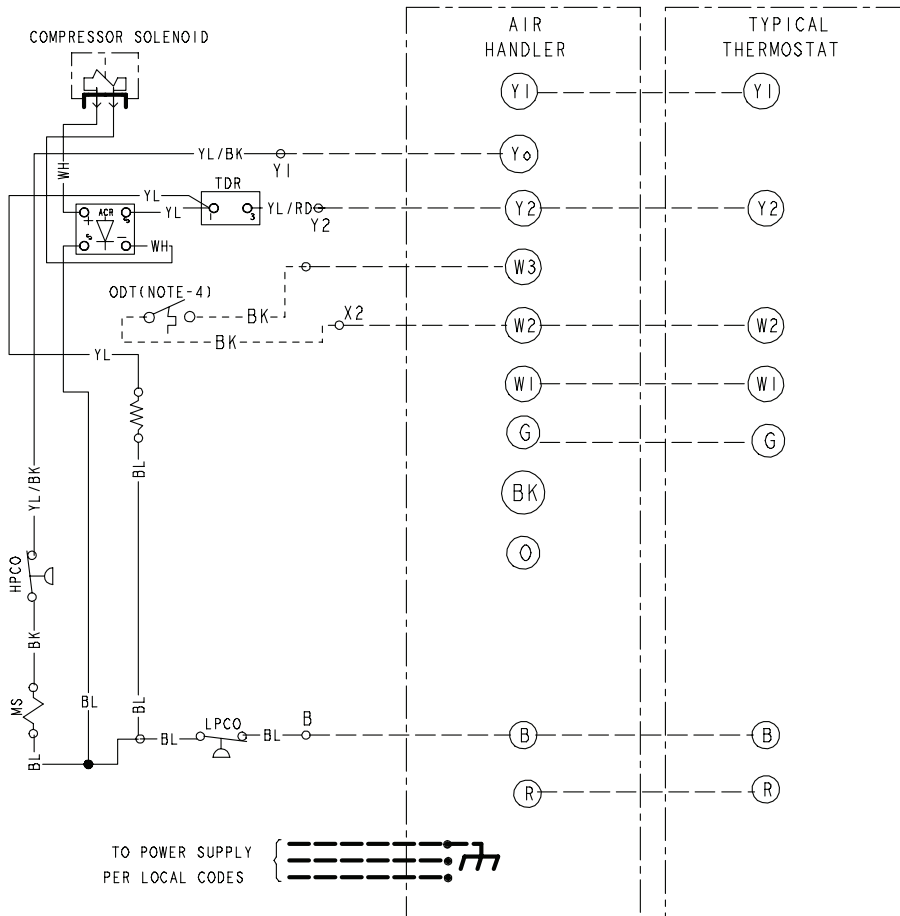

TO POWER SUPPLY PER LOCAL CODES

NOTES:





















1. BE SURE POWER SUPPLY AGREES WITH EQUIPMENT NAMEPLATE.
2. POWER WIRING AND GROUNDING OF EQUIPMENT MUST COMPLY WITH LOCAL CODES.
3. LOW VOLTAGE WIRING MUST BE 18 AWG MINIMUM CONDUCTOR.
4. IF OUTDOOR THERMOSTAT IS NOT USED, CONNECT W2 TO W3.
5. WITH Y1 ENERGIZED, INDOOR FAN IS 1ST STAGE AIRFLOW.
6. WITH Y1 & Y2 ENERGIZED, INDOOR FAN IS 2ND STAGE AIRFLOW.
7. SEE AIR HANDLER INSTALLER GUIDE FOR DIP SWITCH CONFIGURATIONS.

FOR CANADIAN INSTALLATIONS
POUR INSTALLATIONS CANADIENNES

CAUTION: NOT SUITABLE FOR USE ON SYSTEMS EXCEEDING 150V-TO-GROUND
ATTENTION: NE CONVIENT PAS AUX INSTALLATIONS DE PLUS DE 150 V A LA TERRE

WIRING DIAGRAM

LEGEND

-  24 V LINE V } FACTORY WIRING
-  24 V LINE V } FIELD WIRING
-  FIELD INSTALLED FACTORY WIRING
-  MAGNETIC COIL
-  GROUND
-  JUNCTION
-  CAPACITOR
-  WIRE NUT OR TERMINAL
-  TRANSFORMER
-  FUSE
-  TERMINAL BLOCK/BOARD
-  RELAY CONTACT (N.O.)
-  RELAY CONTACT (N.C.)
-  THERMISTOR
-  TEMP ACTUATED SWITCH
-  INTERNAL OVERLOAD PROTECTION
-  PRESSURE ACTUATED SWITCH
-  RESISTOR OR HEATING ELEMENT
-  MOTOR WINDING
-  POL. PLUG FEMALE HOUSING (MALE TERMINALS)
-  POL. PLUG MALE HOUSING (FEMALE TERMINALS)

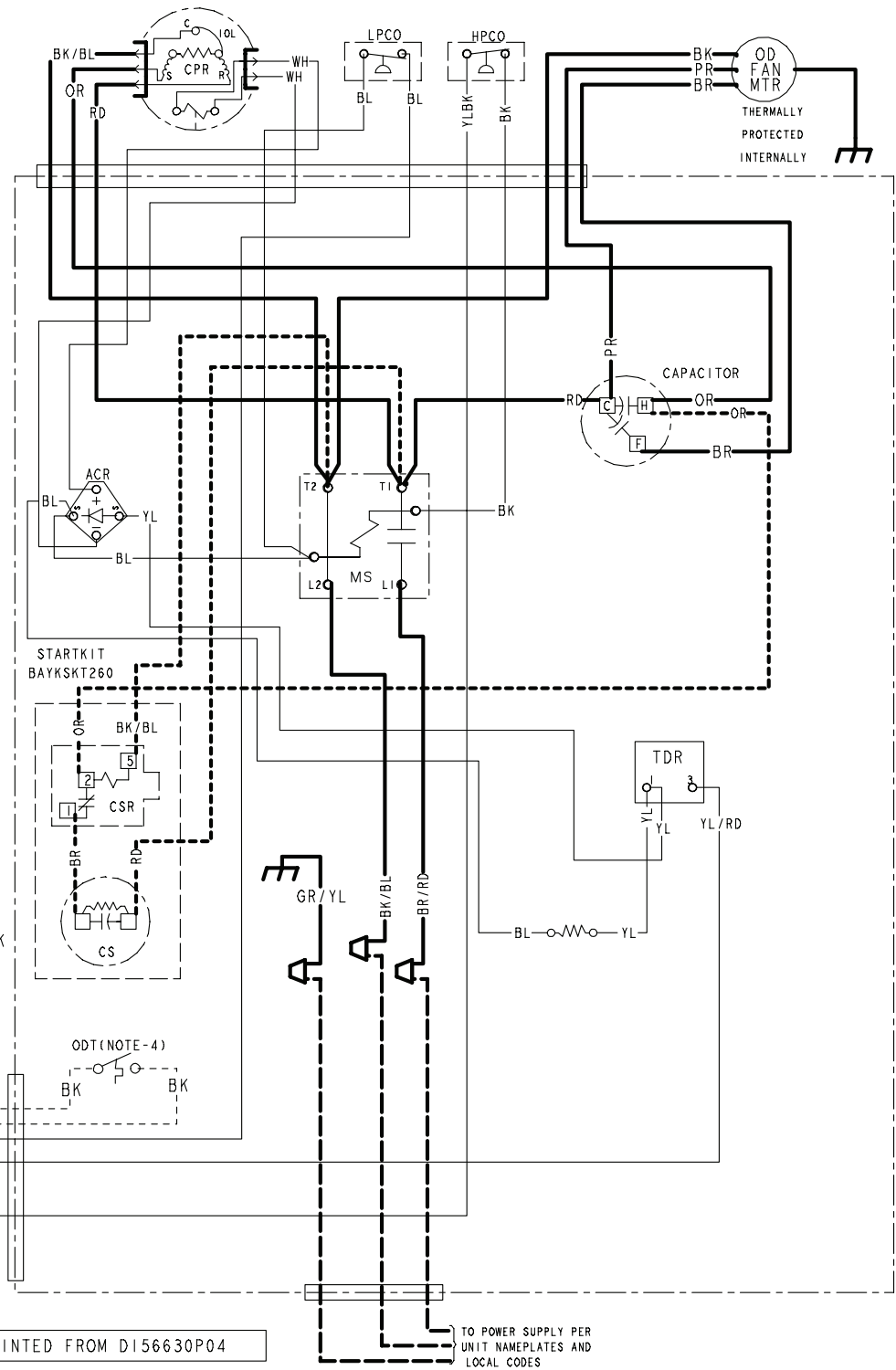

PRINTED FROM D156630P04

TO POWER SUPPLY PER
UNIT NAMEPLATES AND
LOCAL CODES

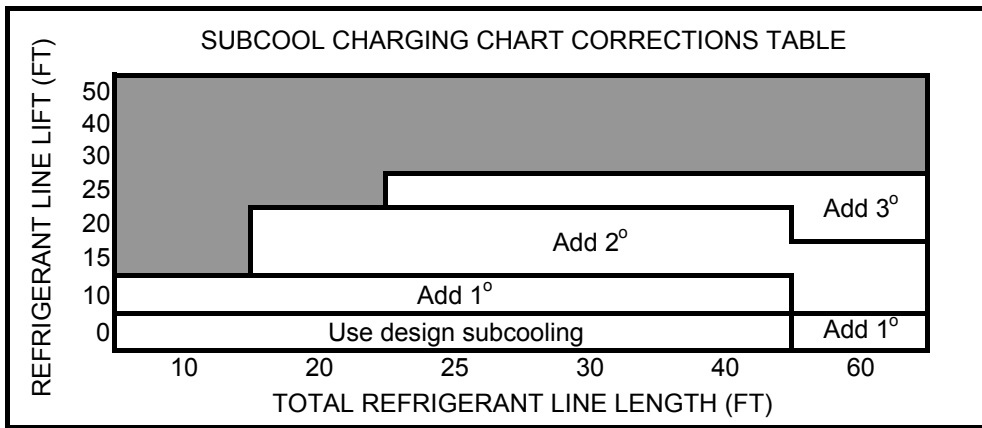

MANUAL CHARGING (HIGH STAGE ONLY) IN COOLING BETWEEN 55°F AND 120°F OD AMBIENT

Trane recommends installing Trane approved matched indoor and outdoor systems. All Trane split systems are AHRI rated with only TXV indoor systems.

The benefits of installing approved indoor and outdoor split systems are maximum efficiency, optimum performance and the best overall system reliability.

The following charging methods are therefore prescribed for systems with indoor TXVs.

1. Subcooling (in the cooling mode) is the only recommended method of charging above 55°F ambient temperatures.
2. For best results - the indoor temperature should be kept between 70°F to 80°F. Add system heat if needed.
3. At start-up, or whenever charge is removed or added, the system must be operated for a minimum twenty (20) minutes to stabilize before accurate measurements can be made.
4. Measure Liquid Line Temperature and Refrigerant Pressure at service valves.
5. Determine total refrigerant line length, and height (lift) if indoor section is above the condenser. Use the **Subcool Charging Chart Corrections Table** to calculate any additional subcooling required for your specific application.
6. Determine the Design Subcooling from the unit nameplate or Service Facts. Add any additional amount of subcooling calculated in Step 5 to the Design Subcooling to arrive at the final subcooling value.
7. Locate this value in the appropriate column of the **R-410-A Refrigerant Charging Chart**. Locate your liquid line temperature in the left column of the chart, and the intersecting liquid line pressure under your calculated subcooling value column. Add refrigerant to raise the pressure to match the chart, or remove refrigerant to lower the pressure. Again, wait twenty (20) minutes for the system conditions to stabilize before adjusting charge again.
8. When system is correctly charged, you can refer to System Pressure Curves (in Service Facts) to verify typical performance.

R-410A REFRIGERANT CHARGING CHART								
LIQUID TEMP (°F)	DESIGN SUBCOOLING (°F)							
	8	9	10	11	12	13	14	
LIQUID GAGE PRESSURE (PSI)								
55	179	182	185	188	191	195	198	
60	195	198	201	204	208	211	215	
65	211	215	218	222	225	229	232	
70	229	232	236	240	243	247	251	
75	247	251	255	259	263	267	271	
80	267	271	275	279	283	287	291	
85	287	291	296	300	304	309	313	
90	309	313	318	322	327	331	336	
95	331	336	341	346	351	355	360	
100	355	360	365	370	376	381	386	
105	381	386	391	396	402	407	413	
110	407	413	418	424	429	435	441	
115	435	441	446	452	458	464	470	
120	464	470	476	482	488	495	501	
125	495	501	507	514	520	527	533	
Refer to Service Facts or Installer's Guide for charging method.								

From Dwg. D154557P01 Rev. 3

REFRIGERATION CIRCUITS

Cooling Refrigeration Cycle

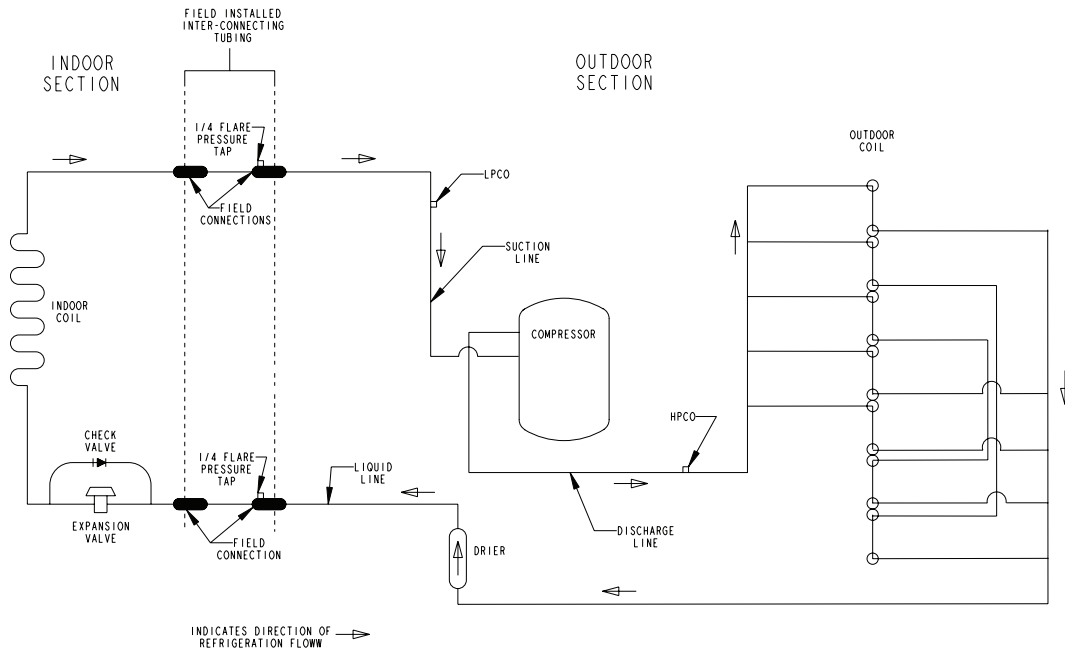

TROUBLESHOOTING

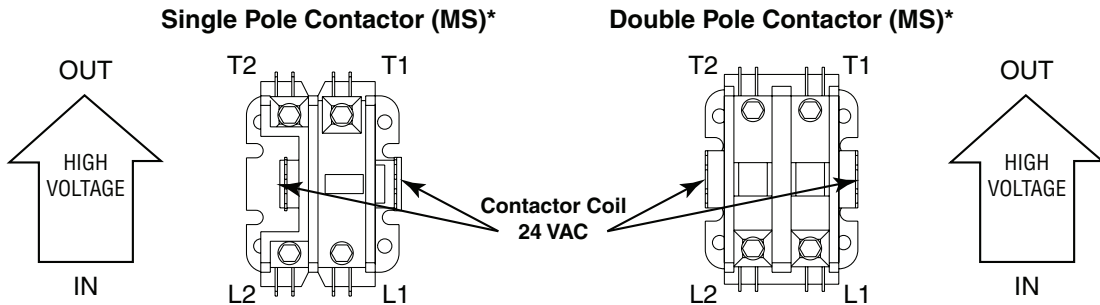
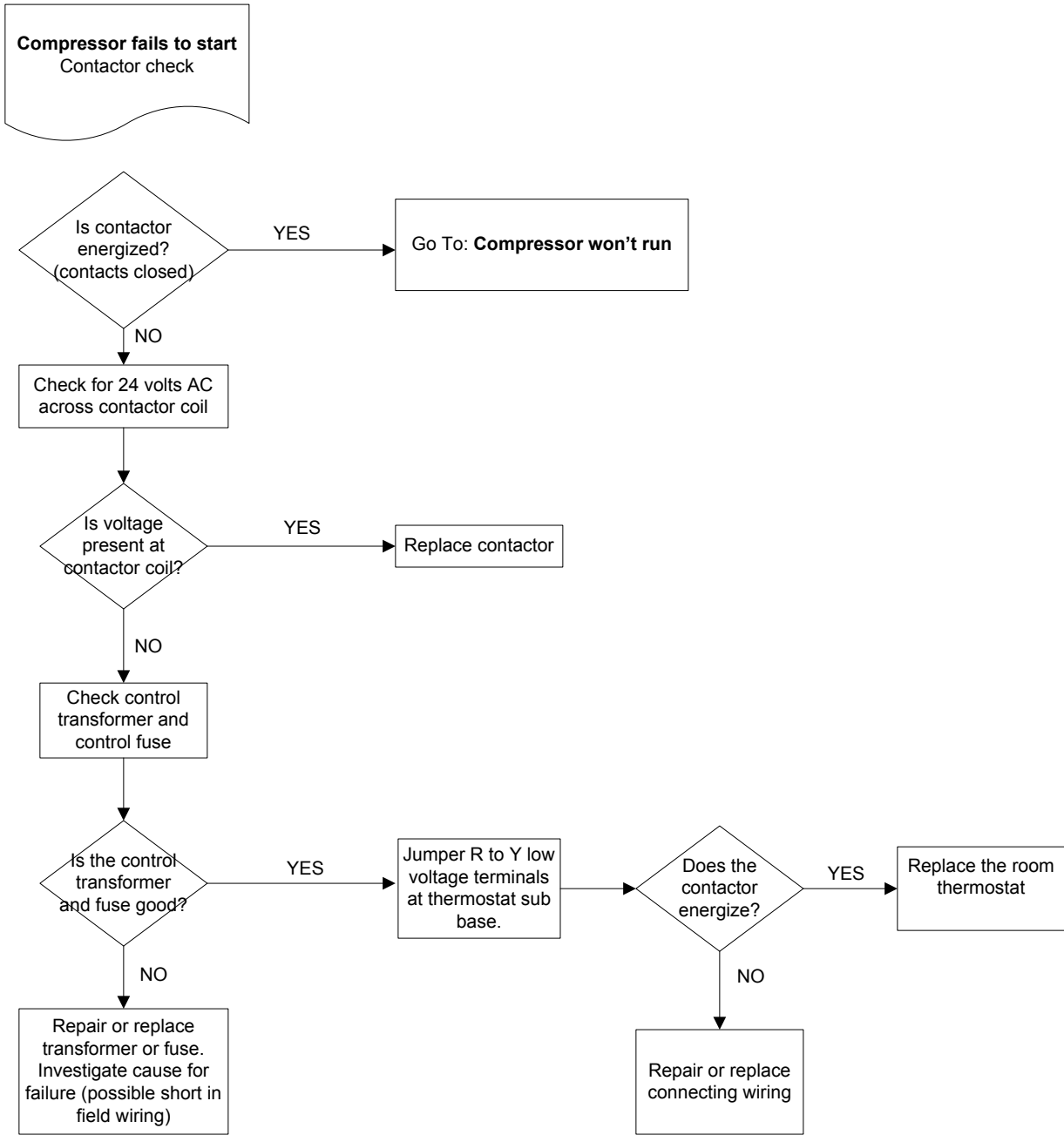

*Refer to Wiring Diagram to determine if a single pole or double pole contactor is used.

TROUBLESHOOTING

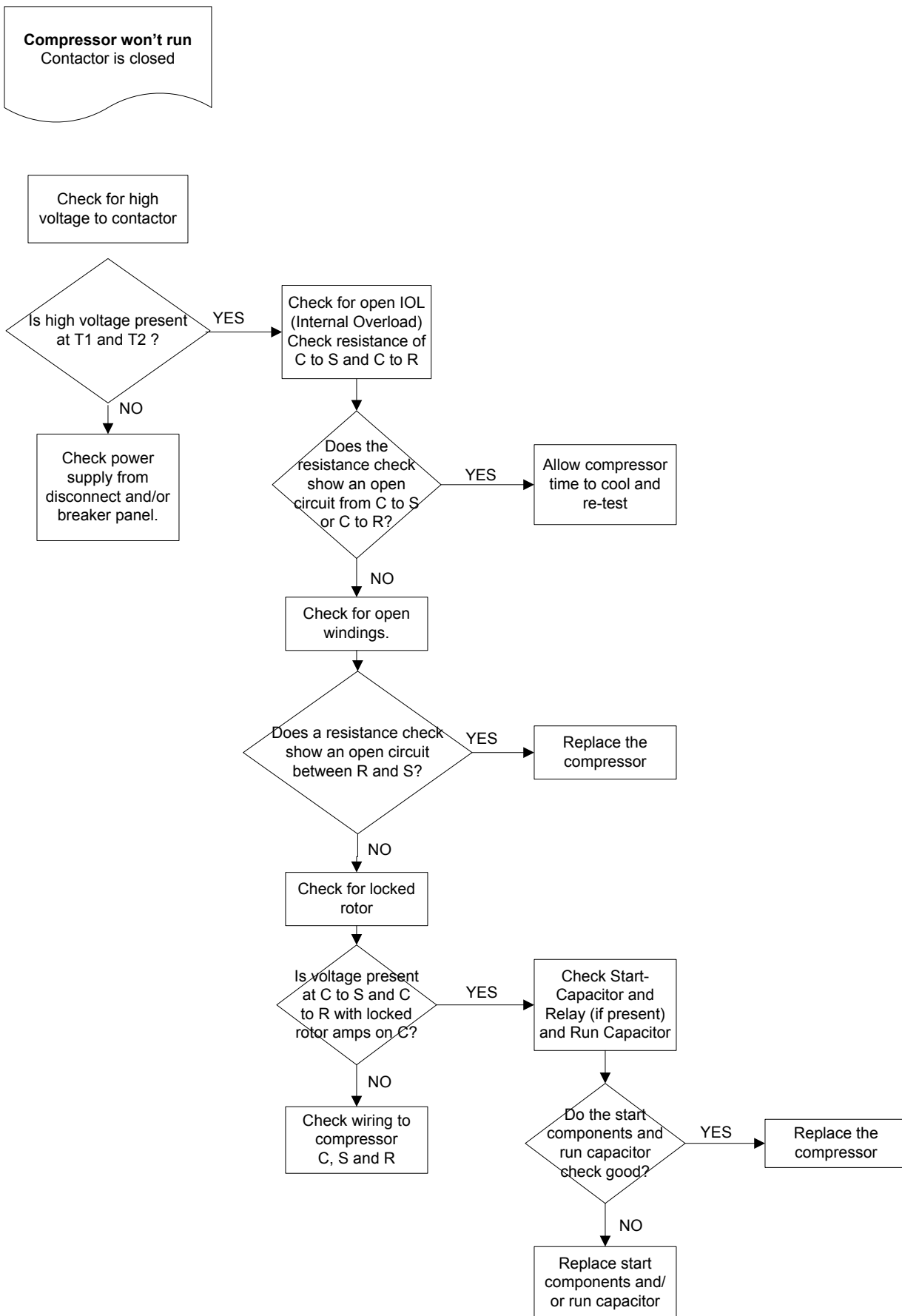

PRESSURE CURVES FOR 4TTR6036A1

**FIRST STAGE
TAM7A0C36H31**

Cooling with Thermal Expansion Valve

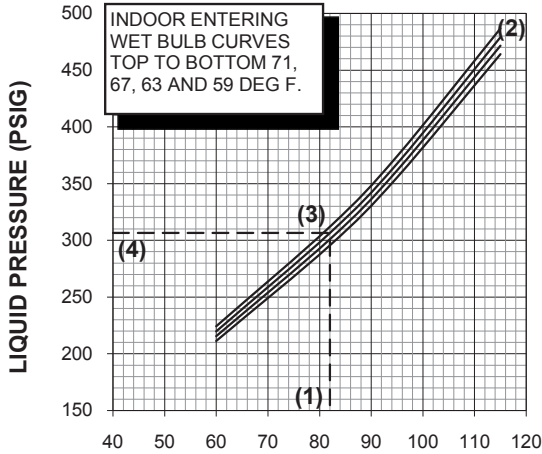

**SECOND STAGE
TAM7A0C36H31**

Cooling with Thermal Expansion Valve

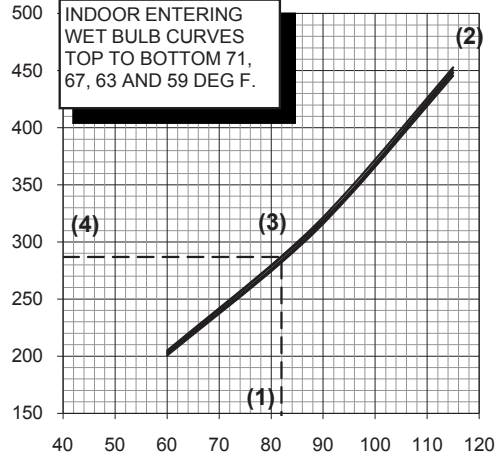

OUTDOOR TEMPERATURE (Degree F)

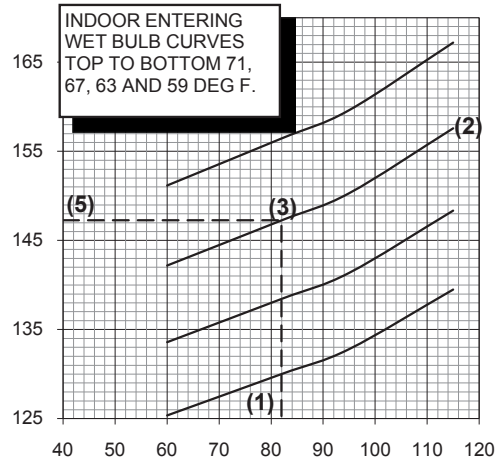
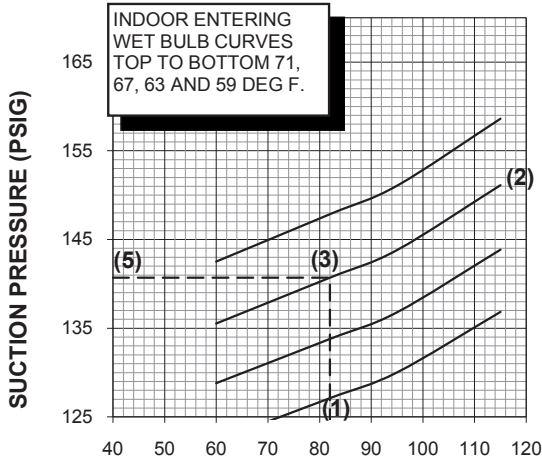

OUTDOOR TEMPERATURE (Degree F)

COOLING PERFORMANCE CAN BE CHECKED WHEN THE OUTDOOR TEMP IS ABOVE 65 DEG F.

TO CHECK COOLING PERFORMANCE, SELECT THE PROPER INDOOR CFM, ALLOW PRESSURES TO STABILIZE. MEASURE INDOOR WET BULB TEMPERATURE, OUTDOOR TEMPERATURE, LIQUID AND SUCTION PRESSURES. ON THE PLOTS LOCATE OUTDOOR TEMPERATURE (1); LOCATE INDOOR WET BULB (2); FIND INTERSECTION OF OD TEMP. & ID W.B. (3); READ LIQUID (4) OR SUCTION (5) PRESSURE IN LEFT COLUMN.

EXAMPLE: FIRST STAGE

- (1) OUTDOOR TEMP. 82 F.
- (2) INDOOR WET BULB 67 F.
- (3) AT INTERSECTION
- (4) LIQUID PRESSURE @ 780 CFM IS 307 PSIG
- (5) SUCTION PRESSURE @ 780 CFM IS 141 PSIG

EXAMPLE: SECOND STAGE

- (1) OUTDOOR TEMP. 82 F.
- (2) INDOOR WET BULB 67 F.
- (3) AT INTERSECTION
- (4) LIQUID PRESSURE @ 1050 CFM IS 287 PSIG
- (5) SUCTION PRESSURE @ 1050 CFM IS 147 PSIG

INTERCONNECTING LINES
GAS - 3/4" O.D.
LIQUID - 3/8" O.D.

ACTUAL:

LIQUID PRESSURE SHOULD BE +/- 10 PSI OF CHART
SUCTION PRESSURE SHOULD BE +/- 3 PSIG OF CHART

DWG.NO. 4TTR6036A1

