



TRANE®

Service Facts

4TTX6048H-SF-1

Split System Cooling 4TTX6048H1000A

IMPORTANT — This document contains a wiring diagram, a parts list, and service information. This is customer property and is to remain with this unit. Please return to service information pack upon completion of work.

⚠ CAUTION

UNIT CONTAINS R-410A REFRIGERANT!
R-410A OPERATING PRESSURE EXCEEDS THE LIMIT OF R-22. PROPER SERVICE EQUIPMENT IS REQUIRED. FAILURE TO USE PROPER SERVICE TOOLS MAY RESULT IN EQUIPMENT DAMAGE OR PERSONAL INJURY.

SERVICE
USE ONLY R-410A REFRIGERANT AND APPROVED POE COMPRESSOR OIL.

⚠ WARNING: HAZARDOUS VOLTAGE - DISCONNECT POWER and DISCHARGE CAPACITORS BEFORE SERVICING

PRODUCT SPECIFICATIONS

OUTDOOR UNIT ①②	4TTX6048H1000A
POWER CONNS. — V/PH/HZ ③	208/230/1/60
MIN. BRCH. CIR. AMPACITY	28
BR. CIR. PROT. RTG. - MAX. (AMPS)	50
COMPRESSOR	CLIMATUFF® - SCROLL
NO. USED - NO. SPEEDS	1 - 1
VOLTS/PH/HZ	208/230/1/60
R.L. AMPS ⑦ - L.R. AMPS	21.8 - 117
FACTORY INSTALLED	
START COMPONENTS ⑧	NO
INSULATION/SOUND BLANKET	YES
COMPRESSOR HEAT	NO
OUTDOOR FAN	PROPELLER
DIA. (IN.) - NO. USED	26.6 - 1
TYPE DRIVE - NO. SPEEDS	DIRECT - 1
CFM @ 0.0 IN. W.G. ④	4160
NO. MOTORS - HP	1 - 1/5
MOTOR SPEED R.P.M.	835
VOLTS/PH/HZ	200/230/1/60
F.L. AMPS	0.93
OUTDOOR COIL — TYPE	SPINE FIN™
ROWS - F.P.I.	1 - 24
FACE AREA (SQ. FT.)	30.79
TUBE SIZE (IN.)	3/8
REFRIGERANT	
LBS. — R-410A (O.D. UNIT) ⑤	11 LBS., 0 OZ.
FACTORY SUPPLIED	YES
LINE SIZE - IN. O.D. GAS ⑥	7/8
LINE SIZE - IN. O.D. LIQ. ⑥	3/8
CHARGING SPECIFICATION	
SUBCOOLING	9°F
DIMENSIONS	H X W X D
CRATED (IN.)	57.4 x 35.1 x 38.7
WEIGHT	
SHIPPING (LBS.)	352
NET (LBS.)	302

TUBING INFORMATION

Tubing Sizes		Tubing Length	Additional Refrigerant
Suction	Liquid		
7/8"	3/8"	20'	4 oz.
7/8"	3/8"	30'	11 oz.
7/8"	3/8"	40'	18 oz.
7/8"	3/8"	50'	25 oz.
7/8"	3/8"	60'	32 oz.

Tubing lengths in excess of sixty (60) feet see application software.

- ① Certified in accordance with the Air-Source Unitary Air-conditioner Equipment certification program, which is based on AHRI standard 210/240.
- ② Rated in accordance with AHRI standard 270.
- ③ Calculated in accordance with Natl. Elec. Codes. Use only HACR circuit breakers or fuses.
- ④ Standard Air — Dry Coil — Outdoor
- ⑤ This value approximate. For more precise value see unit nameplate.
- ⑥ Max. linear length 60 ft.; Max. lift - Suction 60 ft.; Max lift - Liquid 60 ft. For greater length consult refrigerant piping software Pub. No. 32-3312-0* (* denotes latest revision).
- ⑦ This value shown for compressor RLA on the unit nameplate and on this specification sheet is used to compute minimum branch circuit ampacity and max. fuse size. The value shown is the branch circuit selection current.
- ⑧ No means no start components. Yes means quick start kit components. PTC means positive temperature coefficient starter.

⚠ CAUTION

HOT SURFACE!
DO NOT TOUCH TOP OF COMPRESSOR.
May cause minor to severe burning.

⚠ CAUTION

CONTAINS REFRIGERANT!
SYSTEM CONTAINS OIL AND REFRIGERANT UNDER HIGH PRESSURE. RECOVER REFRIGERANT TO RELIEVE PRESSURE BEFORE OPENING SYSTEM.
Failure to follow proper procedures can result in personal illness or injury or severe equipment damage.

⚠ WARNING

THIS INFORMATION IS INTENDED FOR USE BY INDIVIDUALS POSSESSING ADEQUATE BACKGROUNDS OF ELECTRICAL AND MECHANICAL EXPERIENCE. ANY ATTEMPT TO REPAIR A CENTRAL AIR CONDITIONING PRODUCT MAY RESULT IN PERSONAL INJURY AND OR PROPERTY DAMAGE. THE MANUFACTURER OR SELLER CANNOT BE RESPONSIBLE FOR THE INTERPRETATION OF THIS INFORMATION, NOR CAN IT ASSUME ANY LIABILITY IN CONNECTION WITH ITS USE.

⚠ CAUTION

RECONNECT ALL GROUNDING DEVICES.
ALL PARTS OF THIS PRODUCT CAPABLE OF CONDUCTING ELECTRICAL CURRENT ARE GROUNDED. IF GROUNDING WIRES, SCREWS, STRAPS, CLIPS, NUTS OR WASHERS USED TO COMPLETE A PATH TO GROUND ARE REMOVED FOR SERVICE, THEY MUST BE RETURNED TO THEIR ORIGINAL POSITION AND PROPERLY FASTENED.

NOTICE: Trane has a policy of continuous product and product data improvement and it reserves the right to change design and specifications without notice.

SCHEMATIC DIAGRAM

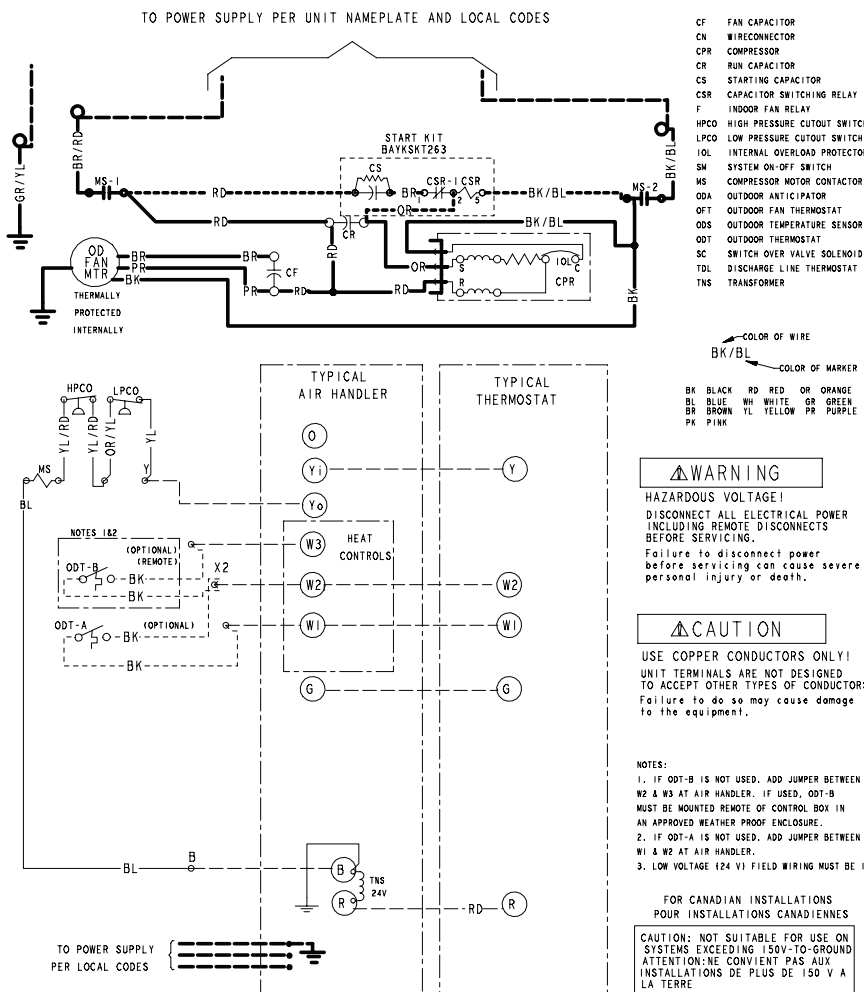

SUBCOOLING CHARGING IN COOLING ABOVE 55°F OD AMBIENT

Trane has always recommended installing Trane approved matched indoor and outdoor systems.

All Trane split systems are AHRI rated with only TXV indoor systems.

The benefits of installing approved indoor and outdoor split systems are maximum efficiency, optimum performance and the best overall system reliability.

The following charging methods are therefore prescribed for systems with indoor TXVs.

1. Subcooling (in the cooling mode) is the only recommended method of charging above 55°F ambient temperatures.
2. For best results – the indoor temperature should be kept between 70°F to 80°F. Add system heat if needed.
3. At startup, or whenever charge is removed or added, the system must be operated for a minimum 20 minutes to stabilize before accurate measurements can be made.
4. Measure Liquid Line Temperature and Refrigerant Pressure at service valves.
5. Determine total refrigerant line length, and height (lift) if indoor section is above the condenser.

6. Determine the Design Subcool Charging Temperature from the unit nameplate.
7. Locate this value in the appropriate column of the Subcooling Charging Table. Locate your liquid line temperature in the left column of the table, and the intersecting liquid line pressure under your nameplate subcool value column. Add refrigerant to raise the pressure to match the table, or remove refrigerant to lower the pressure. Again, wait 20 minutes for the system conditions to stabilize before adjusting charge again.
8. When system is correctly charged, you can refer to System Pressure Curves (on page 4) to verify typical performance.

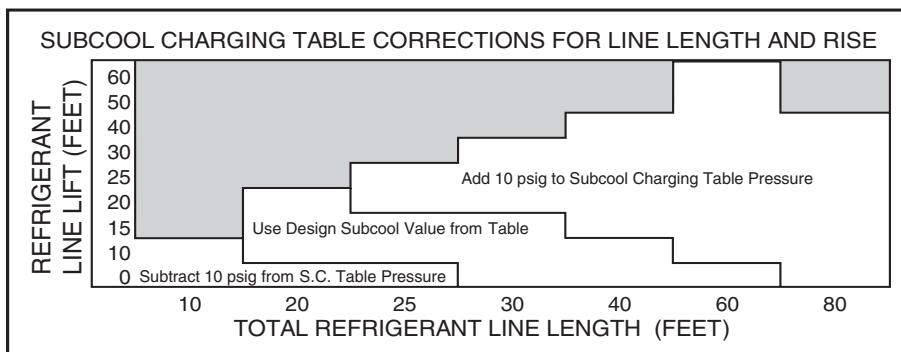

WIRING DIAGRAM

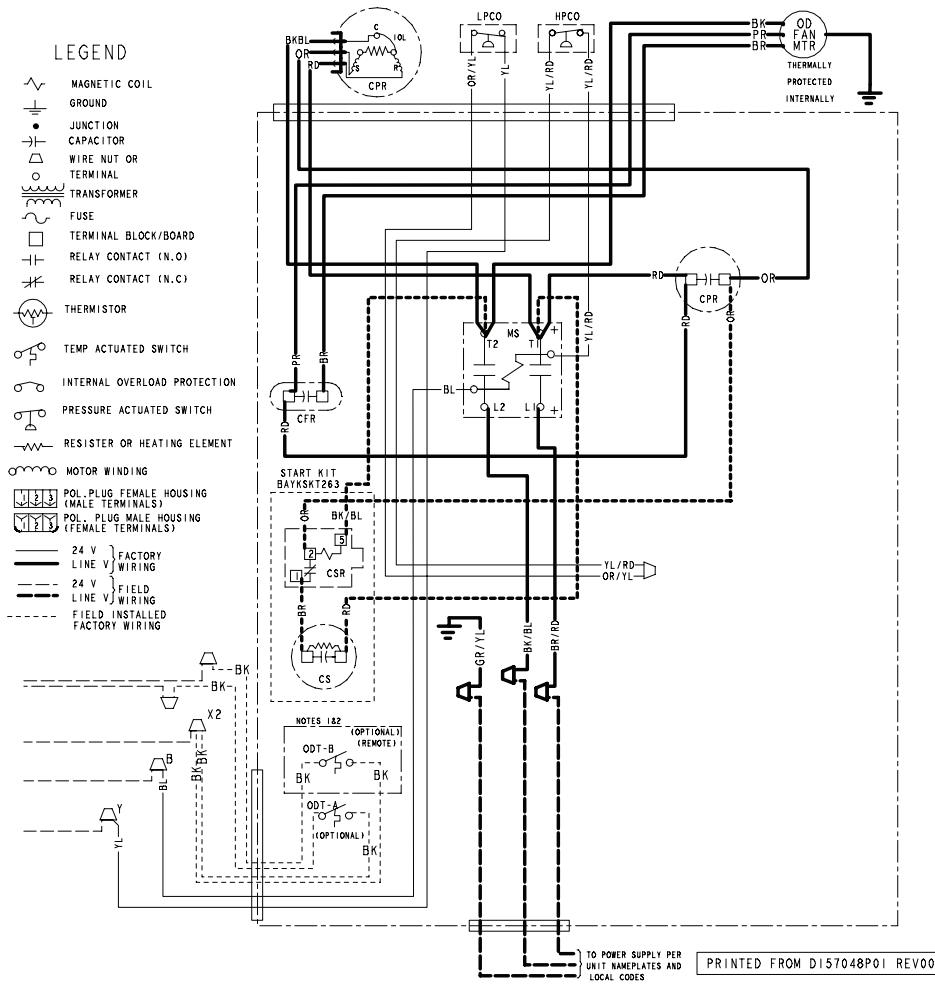

R-410A REFRIGERANT CHARGING CHART							
LIQUID TEMP (°F)	DESIGN SUBCOOLING (°F)						
	8	9	10	11	12	13	14
	LIQUID GAGE PRESSURE (PSI)						
55	179	182	185	188	191	195	198
60	195	198	201	204	208	211	215
65	211	215	218	222	225	229	232
70	229	232	236	240	243	247	251
75	247	251	255	259	263	267	271
80	267	271	275	279	283	287	291
85	287	291	296	300	304	309	313
90	309	313	318	322	327	331	336
95	331	336	341	346	351	355	360
100	355	360	365	370	376	381	386
105	381	386	391	396	402	407	413
110	407	413	418	424	429	435	441
115	435	441	446	452	458	464	470
120	464	470	476	482	488	495	501
125	495	501	507	514	520	527	533
Refer to Service Facts or Installer's Guide for charging method.							

TROUBLESHOOTING

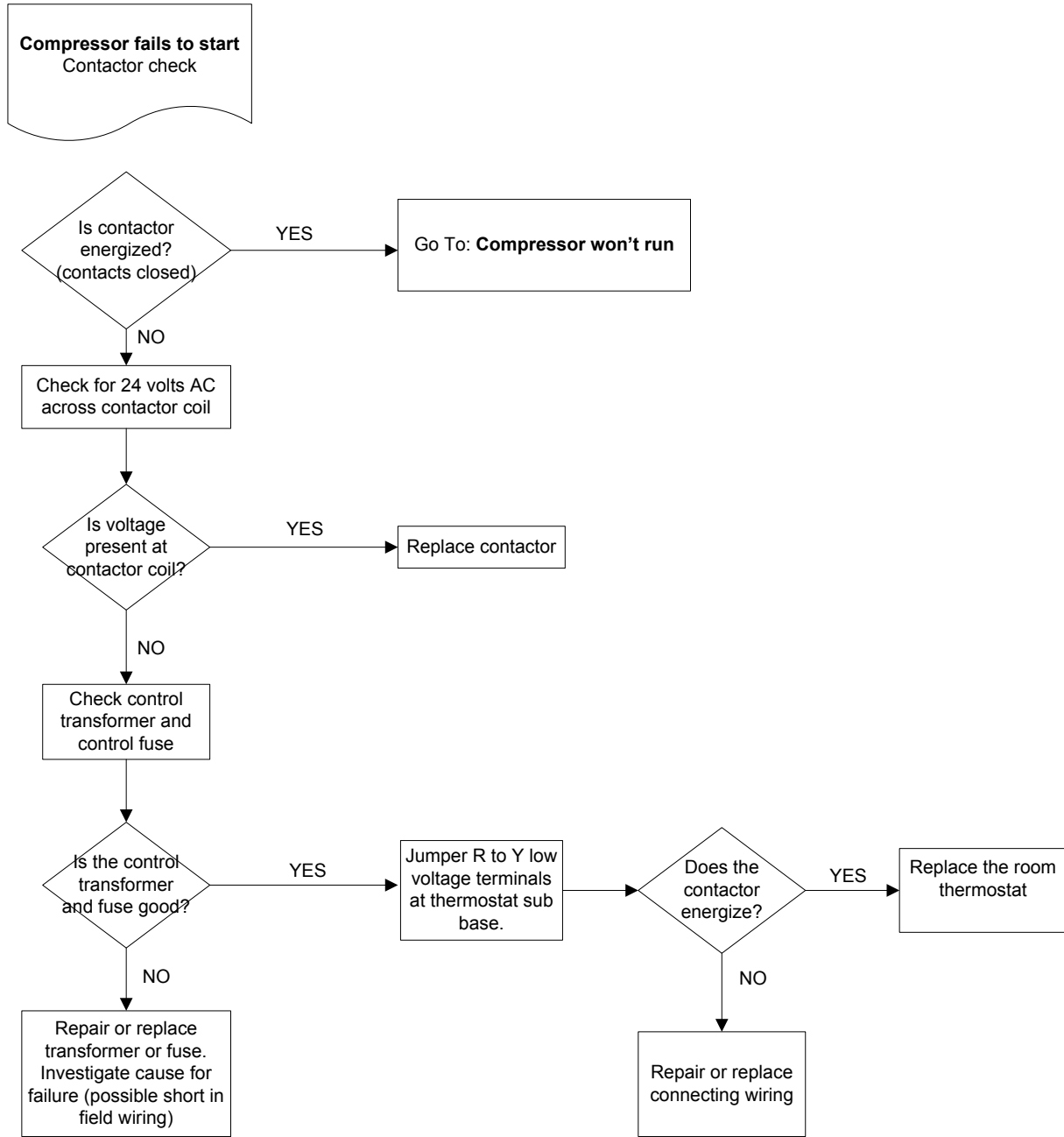

Single Pole Contactor (MS)*

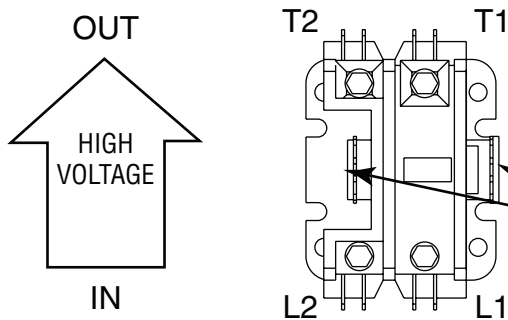

Double Pole Contactor (MS)*

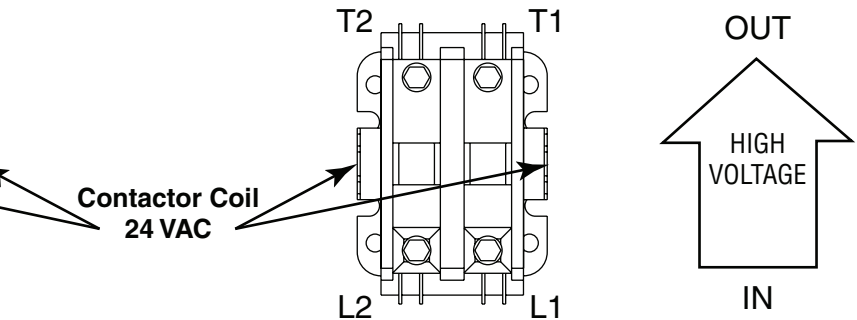

*Refer to Wiring Diagram to determine if a single pole or double pole contactor is used.

TROUBLESHOOTING

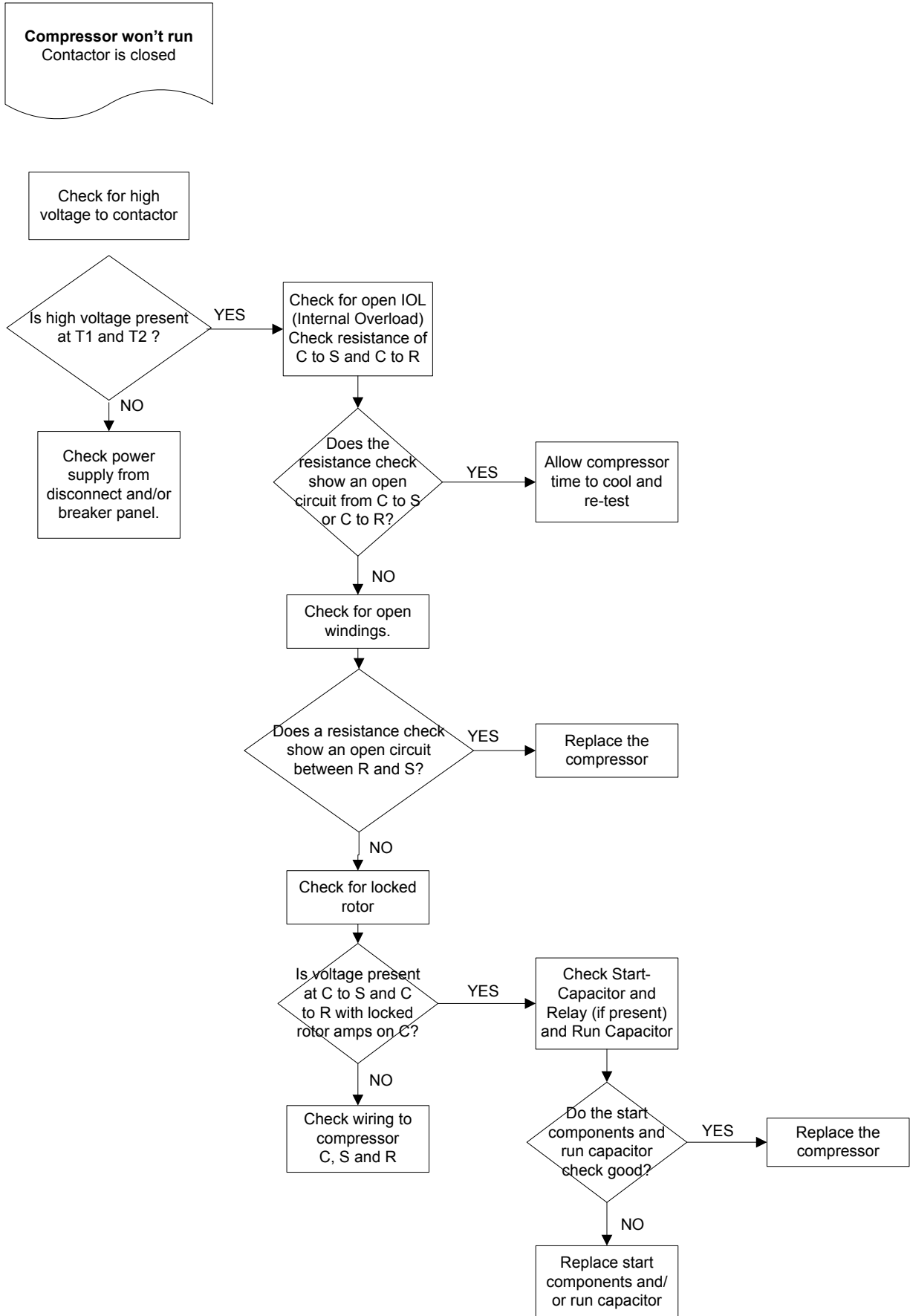

REFRIGERANT CIRCUIT

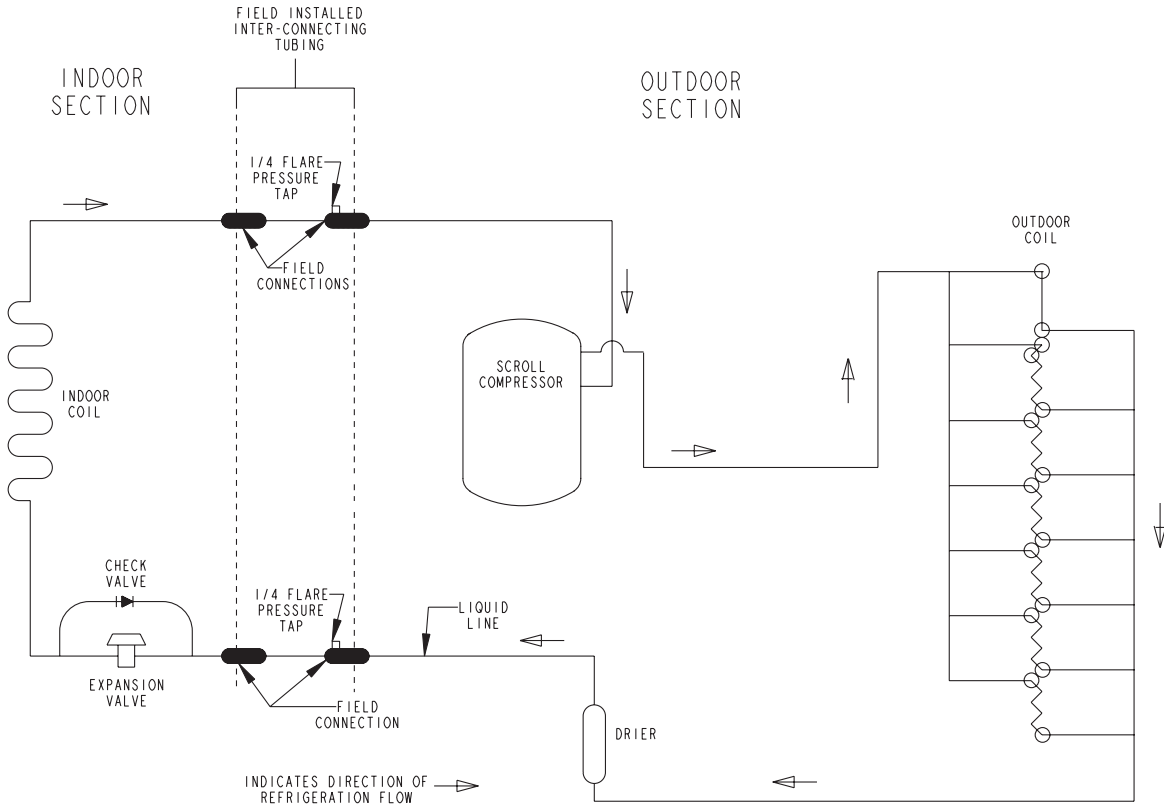

COOLING REFRIGERATION CYCLE

PRINTED FROM D155234 REV 00

PRESSURE CURVES FOR 4TTX6048H1

4TXCD061BC3

Cooling with Thermal Expansion Valve

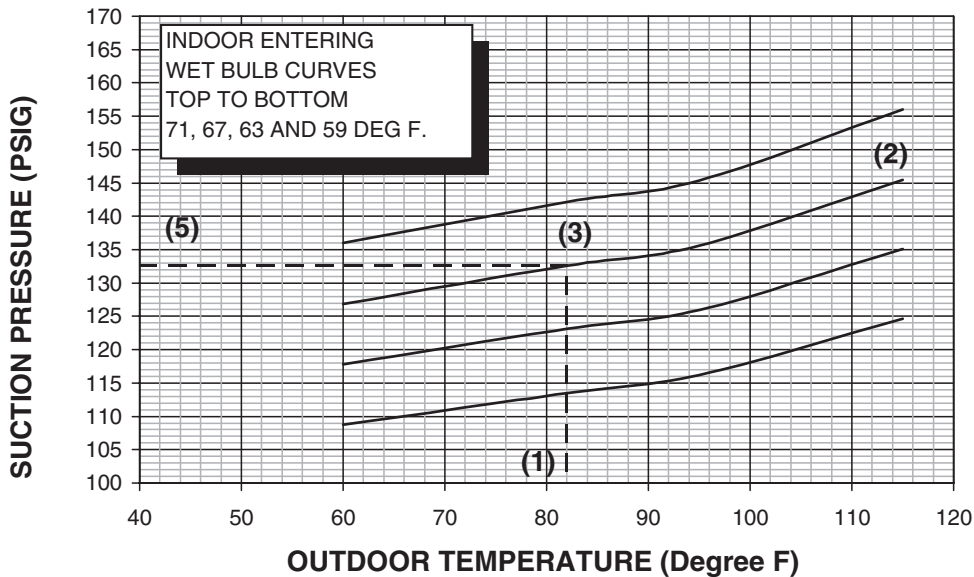
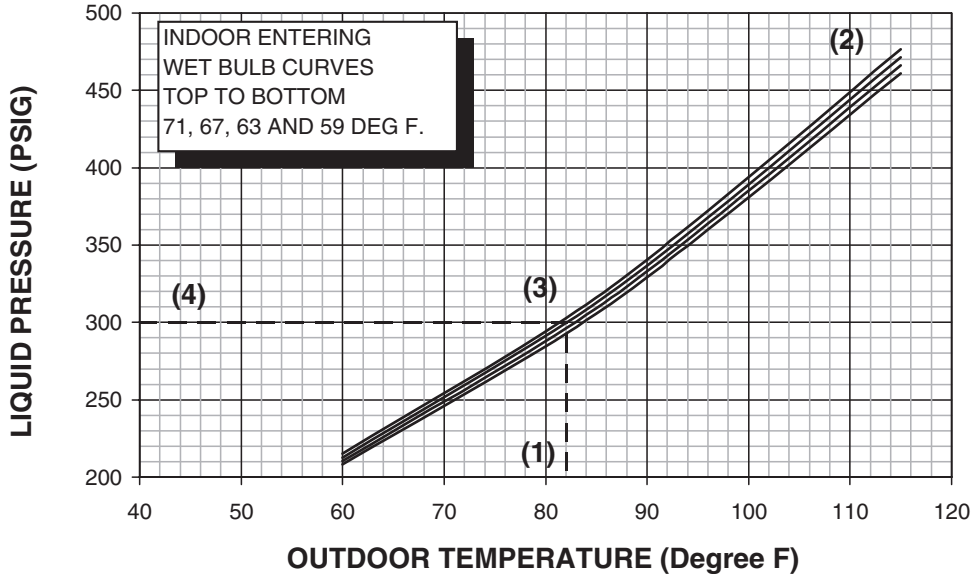

COOLING PERFORMANCE CAN BE CHECKED WHEN THE OUTDOOR TEMP IS ABOVE 65 DEG F.

TO CHECK COOLING PERFORMANCE, SELECT THE PROPER INDOOR CFM, ALLOW PRESSURES TO STABILIZE. MEASURE INDOOR WET BULB TEMPERATURE, OUTDOOR TEMPERATURE, LIQUID AND SUCTION PRESSURES. ON THE PLOTS LOCATE OUTDOOR TEMPERATURE (1); LOCATE INDOOR WET BULB (2); FIND INTERSECTION OF OD TEMP. & ID W.B. (3); READ LIQUID (4) OR SUCTION (5) PRESSURE IN LEFT COLUMN.

EXAMPLE: (1) OUTDOOR TEMP. 82 F.
 (2) INDOOR WET BULB 67 F.
 (3) AT INTERSECTION
 (4) LIQUID PRESSURE @ 1390 CFM IS 300 PSIG
 (5) SUCTION PRESSURE @ 1390 CFM IS 133 PSIG

ACTUAL:
 LIQUID PRESSURE SHOULD BE +/- 10 PSI OF CHART
 SUCTION PRESSURE SHOULD BE +/- 3 PSIG OF CHART

INTERCONNECTING LINES
 GAS - 7/8 " O.D.
 LIQUID - 3/8 " O.D.

DWG.NO. 4TTX6048H1



Trane
www.trane.com

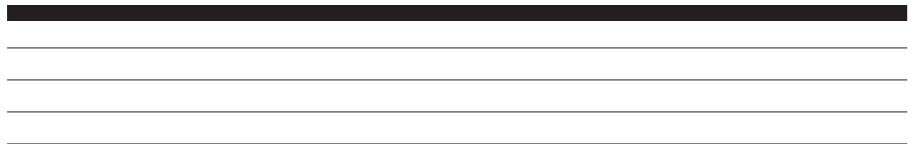

Trane has a policy of continuous product and product data improvement and it reserves the right to change design and specifications without notice.