



Learning Thermostat
Installation Guide

Compatibility

Nest works with over 95% of 24V heating and cooling systems, including gas, electric, oil, solar, hot water, geothermal, forced air, heat pump and radiant. It can control:

- Heating: one, two and three stages (W1, W2, W3)
- Cooling: one and two stages (Y1, Y2)
- Heat pump: with auxiliary and emergency heat (O/B, AUX, E)
- Fan (G)
- Power (C, Rh, Rc)
- Humidifier or dehumidifier (HUM, DEHUM)

Nest's ✪ connector can accept only one of these wires: W3, E, HUM or DEHUM.

Adding a common C wire is not required in 99% of installations.

- Professional installation recommended for:
- Dual fuel systems (heat pump with furnace)
 - Whole-home humidifiers and dehumidifiers

Go to nest.com/works to make sure Nest will work in your home and find out if you'll need Nest Concierge professional installation.

Watch the video

Before you install Nest, watch the installation video at nest.com/support

Questions? Visit support or give us a call at [855-4MY-NEST](tel:855-4MY-NEST).

Contents



Display

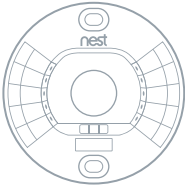

Base



Nest Screwdriver

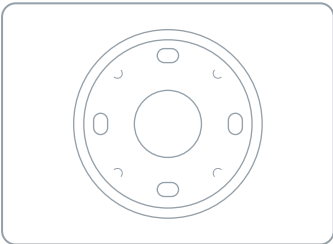

Optional Trim Plate

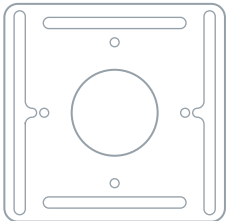

Optional Steel Plate



Wall Screws



Optional Steel Plate Screws

1. Switch off power

This protects you and avoids blowing a fuse. Adjust the temperature on your old thermostat to make sure your system is off.

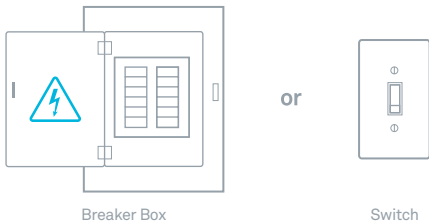

2. Remove cover

Some covers pop off, while others need to be unscrewed.

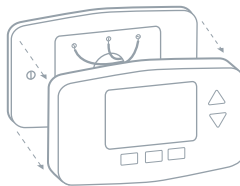

3. Check your system

If your old thermostat is labeled 120V or 240V or has thick wires with wire nuts, your system is high voltage. Not sure? Contact support.

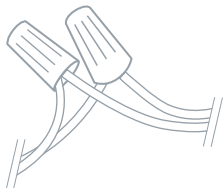

⚠ CAUTION: Do not connect Nest to high voltage wires.

4. Remove any jumper wires

Jumper wires are short wires between two connectors. Nest doesn't need them. An R wire can go into either Rc or Rh.

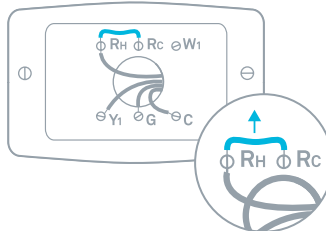

5. Label wires

Peel off the blue labels and attach them to your wires. Use the white labels if you have a E, W3, HUM or DEHUM wire. You can connect only one of these wires to Nest's ★ connector.

HUM and DEHUM wires may require a professional. Check at nest.com/works

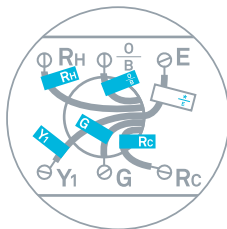

Tip: Take a picture of the wires on your old thermostat to help you remember.

6. Disconnect wires and remove base

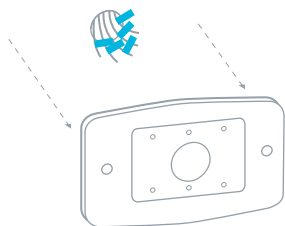

Tip: Wrap the wires around a pencil to keep them from falling into the wall.

7. Mark where screws will go

Use the bubble level to make sure Nest is level.

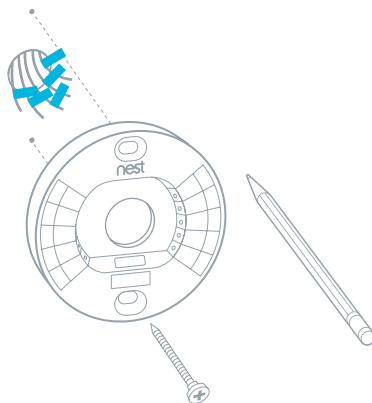

Optional in most homes

Use trim plate if needed

You can cover up holes or marks left by your old thermostat with the optional trim plate.

Place the trim plate on the wall and put the base on top so they snap together, then screw them both to the wall.

The trim plate can be found in the bottom of the Nest box.

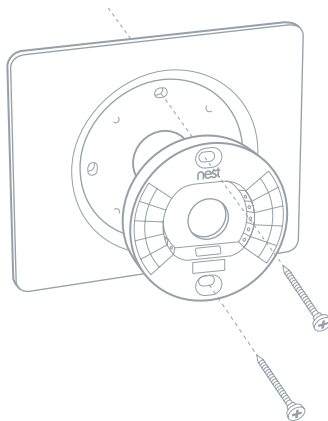

Optional in most homes

Mounting Nest on an electrical box

Electrical boxes aren't common, but if you have one, secure the steel plate to the electrical box with two of the short steel plate screws. Insert the screws into the long slots on the steel plate.

Use the other two short screws to attach the Nest base and trim plate to the steel plate.

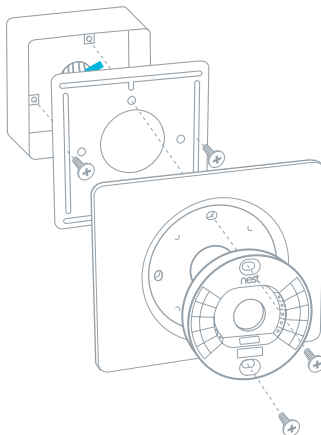

8. Attach base

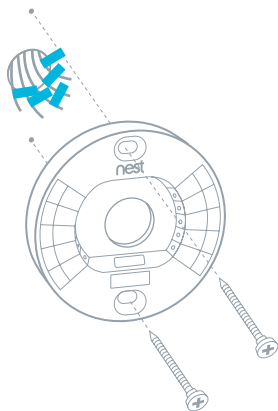

9. Connect wires

After all the wires are connected, make sure they're flush with the wall.

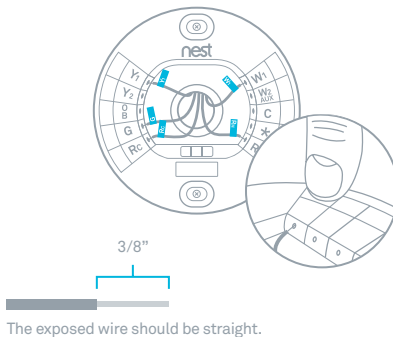

10. Attach display

Press the display until it clicks into place.

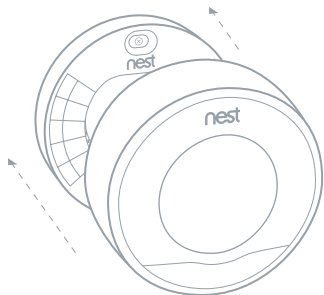

11. Switch power back on

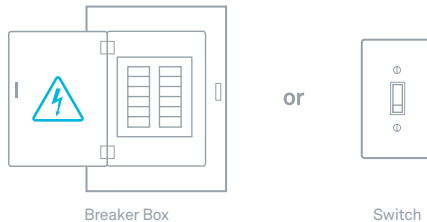

12. Setup and Nest Account

Nest will turn on and walk you through setup. Turn the ring and press to select.

Connect Nest to Wi-Fi during setup, then visit nest.com/account to create a Nest Account so you can control Nest from anywhere.



For more information visit nest.com or call [855-4MY-NEST \(855-469-6378\)](tel:855-4MY-NEST).



Recycle your old thermostat: see nest.com/responsibility

Please recycle Nest's 100% recyclable packaging.



Learning Thermostat
Guía de instalación

Compatibilidad

Nest funciona con más del 95% de los sistemas de enfriamiento y calefacción de 24 V, que incluyen gas, electricidad, aceite, solar, agua caliente, geotérmicos, aire forzado, bomba de calor y radiante. Puede controlar:

- Calentamiento: una, dos y tres etapas (W1, W2, W3)
- Enfriamiento: una o dos etapas (Y1, Y2)
- Bomba de calor: con calor auxiliar y de emergencia (O/B, AUX, E)
- Ventilador (G)
- Energía (C, Rh, Rc)
- Humidificador y deshumidificador (HUM, DEHUM)

El conector de Nest ✪ puede aceptar sólo uno de estos cables: W3, E, HUM o DEHUM.

Agregar el cable común C no es necesario en el 99% de las instalaciones.

Se recomienda instalación profesional para:

- Sistemas de combustible dual (Bomba de calor con caldera)
- Humidificadores y deshumidificadores para todo el hogar

Visita nest.com/compatibilidad para asegurarte de que Nest funcionará en tu hogar y averigua si necesitarás la instalación profesional de Nest Concierge.

Mira el video

Antes de instalar Nest, observa el video de instalación en nest.com/soporte

¿Alguna pregunta? Visita soporte o llámanos al [855-4MY-NEST](https://nest.com/soporte).

Contenido



Pantalla

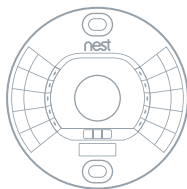

Base



Destornillador Nest

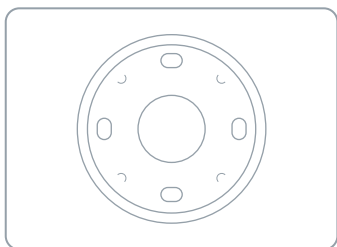

Placa de molde opcional

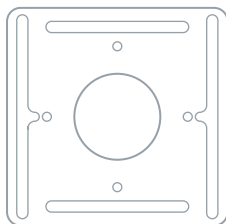

Placa de acero opcional



Tornillos de pared



Tornillos de la placa de acero opcional

1. Apaga la alimentación

Esto te protege y evita que el fusible explote. Ajusta la temperatura de tu viejo termostato para asegurarte de que el sistema esté apagado.



Disyuntor

Interruptor

2. Retira la cubierta

Algunas cubiertas se salen solas, mientras que otras deben destornillarse.

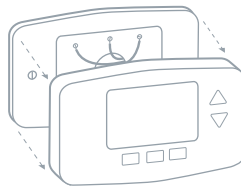

3. Verifica tu sistema

Si tu viejo termostato está etiquetado como 120 V o 240 V o tiene cables gruesos con tuercas, tu sistema es de alto voltaje. ¿No estás seguro? Comunícate con el soporte.

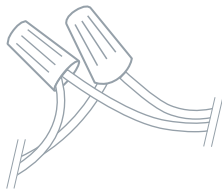

PRECAUCIÓN: No conectes Nest a cables de alto voltaje.

4. Retira los cables de puente

Los cables de puente son cables cortos entre dos conectores. Nest no los necesita. El cable R puede conectarse en Rc o en Rh.

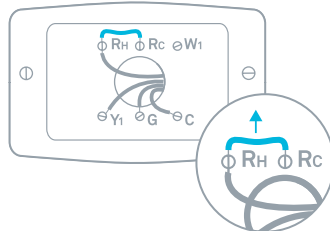

5. Etiqueta los cables

Pela las etiquetas azules y conéctalas a los cables. Utiliza las etiquetas blancas si tienes un cable E, W3, HUM o DEHUM. Solo puedes conectar uno de los siguientes cables al conector estrella de Nest✳.

Los cables HUM y DEHUM pueden requerir un profesional. Visita nest.com/compatibilidad

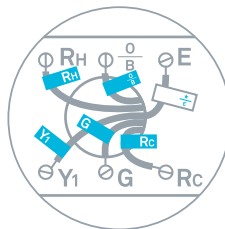

Consulte las instrucciones en inglés para ver los adhesivos de las etiquetas.



Sugerencia: Toma una fotografía de los cables de tu viejo termostato para poder recordarlos.

6. Desconecta los cables y retira la base

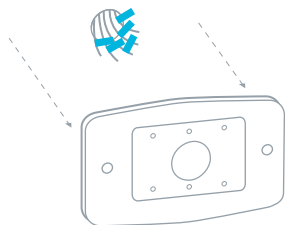

Sugerencia: Enrede los cables alrededor de un lápiz para evitar que caigan en la pared.

7. Marca la ubicación de los tornillos

Utiliza el nivel para asegurarte de que Nest está nivelado.

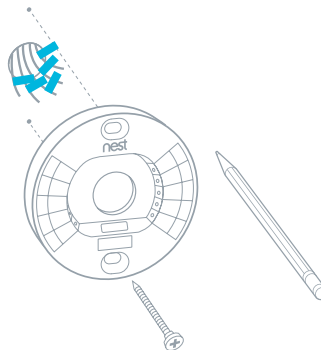

Opcional en la mayoría de los hogares

Utiliza la placa de molde si es necesario

Puedes cubrir los orificios o marcas que dejó tu viejo termostato con la placa de molde opcional.

Coloca la placa de molde en la pared y la base en la parte superior de manera que encajen en conjunto, luego atorníllalas en la pared.

La placa de molde puede encontrarse en la parte inferior de la caja de Nest.

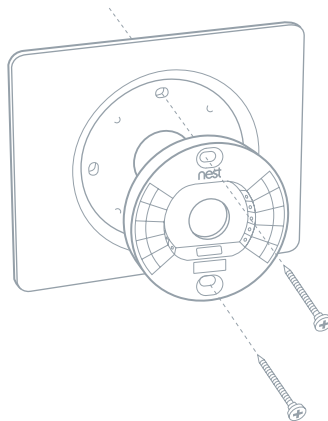

Opcional en la mayoría de los hogares

Montaje de Nest en una caja eléctrica

Las cajas eléctricas no son frecuentes, pero si tienes una, asegura la placa de acero a la caja eléctrica con dos de los tornillos cortos de la placa de acero. Inserte los tornillos en las ranuras largas de la placa de acero.

Utiliza los otros dos tornillos de acero para conectar la base de Nest y la placa de molde a la placa de acero.

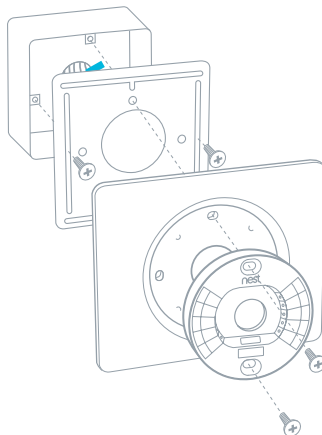

8. Conecta la base

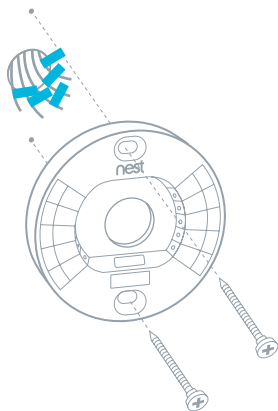

9. Conecta los cables

Después de conectar todos los cables, asegúrate de que estén al ras con la pared.

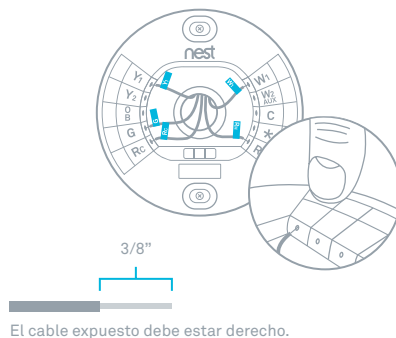

El cable expuesto debe estar derecho.

10. Conecta la pantalla

Presiona la pantalla hasta que haga clic en su lugar.

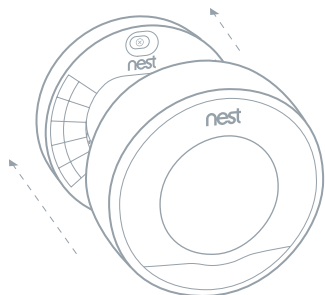

11. Vuelve a encender la alimentación

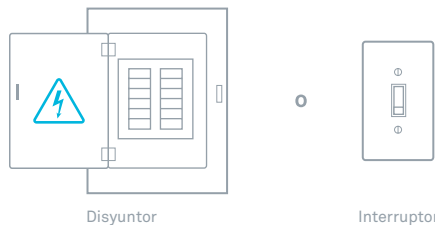

12. Ajustes y cuenta de Nest

Nest se encenderá y te guiará en la configuración. Gira el anillo y presiona para seleccionar.

Conecta Nest a Wi-Fi durante la configuración, luego visita nest.com/cuenta para crear una cuenta de Nest y poder controlar Nest desde cualquier lugar.



Para obtener más información, visita nest.com o llama al [855-4MY-NEST \(855-469-6378\)](tel:855-4MY-NEST).



Recicla tu viejo termostato: visita nest.com/responsibilidad

Recicle el material de embalaje 100% reciclable de Nest.